



Black  
Stove Pipe  
& Accessories

Tuyaux noirs  
pour poêles  
& accessoires



Tubos negros  
para estufas  
& accesorios

# Index / Sommaire / Contenido

Black Stove Pipe / ..... 2 Tuyaux noirs / Tubos de evacuación negros	Caps / ..... 4 Bouchons / Tapas	Tile Connector Adapter / ..... 5 Adapateur pour le connecteur pour tuile / Adaptador para el conector de arcilla	Reducers / ..... 7 Réducteurs / Reductores
Telescoping Stove Pipe / ..... 3 Tuyaux télescopiques / Tubos telescópicos para estufa	Wall Trim Collars / ..... 4 Collets muraux décoratifs / Collares de terminación mural decorativos	Standard Shields / ..... 6 Écrans standards / Escudos estándar	Increasesers / ..... 7 Agrandisseurs / Aumentadores
Slip Connectors / ..... 3 Connecteurs coulissants / Conectores deslizantes	Stove Pipe Section With Damper / ..... 5 Section de tuyau avec clé / Sección de tubo con llave	Telescoping Shields / ..... 6 Écrans télescopiques / Escudos telescópicos	Black Pipe Kits / ..... 7 Ensembles de tuyaux noirs / Kits de tubos de evacuación negros
45° and 90° Elbows / ..... 3 Coudes 45° et 90° / Codos de 45° y 90°	Coupling Sections / ..... 5 Sections d'accouplement / Secciones de acoplamiento	Standard Elbow Shields / ..... 6 Écrans standards pour coudes / Escudos estándar para codos	Heat Shield kit for Black Pipe Kit /.. 7 Ensemble d'écrans pour tuyau / Kit de escudos estándar para tubos
Tees With Cap / ..... 4 Tés avec bouchon / "T" con tapa	Cast Iron Connector for Tile / ..... 5 Connecteur en fonte pour tuile / Conector en hierro fundido para baldosa	Stove Connectors / ..... 6 Connecteurs pour poêle / Conectores para estufa	Self Tapping Screws / ..... 7 Vis auto-perçantes / Tornillos de autopercusión

SKU # # ITEM # SKU	PRODUCT DESCRIPTION DESCRIPTION DU PRODUIT DESCRIPCIÓN DEL PRODUCTO	CONSUMER PACKAGING EMBALLAGE CONSOMMATEUR EMBALAJE DE CONSUMO		MASTER PACKAGING CARTON MAÎTRE EMBALAJE MASTER		UPC CODE CODE CUP CÓDIGO UPC
		TYPE / TIPO	QTY / QTÉ / CANTI.	TYPE / TIPO	QTY / QTÉ / CANTI.	

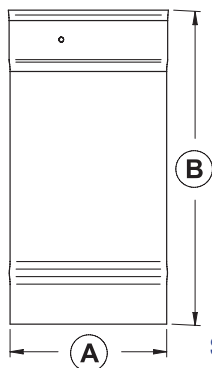

**BLACK STOVE PIPE**  
TUYAU NOIR  
TUBO DE EVACUACIÓN NEGRO

Connects the stove to the chimney systems.  
Utilisé pour connecter le poêle à la cheminée.  
Se utiliza para conectar la estufa al sistema de evacuación.

	AØ	B					
SP00001	6"Ø	12"	VACUUM PACK / SOUS VIDE / AL VACIO	1	BOX / BOÎTE / CAJA	4	773388054674
SP00004	6"Ø	18"	VACUUM PACK / SOUS VIDE / AL VACIO	1	BOX / BOÎTE / CAJA	4	773388054698
SP00007	6"Ø	24"	VACUUM PACK / SOUS VIDE / AL VACIO	1	BOX / BOÎTE / CAJA	4	773388054742
SP00010	6"Ø	36"	VACUUM PACK / SOUS VIDE / AL VACIO	1	BOX / BOÎTE / CAJA	4	773388054773
SP00013	6"Ø	48"	VACUUM PACK / SOUS VIDE / AL VACIO	1	BOX / BOÎTE / CAJA	4	773388064017
SP00002	7"Ø	12"	VACUUM PACK / SOUS VIDE / AL VACIO	1	BOX / BOÎTE / CAJA	4	773388054681
SP00005	7"Ø	18"	VACUUM PACK / SOUS VIDE / AL VACIO	1	BOX / BOÎTE / CAJA	4	773388054728
SP00008	7"Ø	24"	VACUUM PACK / SOUS VIDE / AL VACIO	1	BOX / BOÎTE / CAJA	4	773388054759
SP00011	7"Ø	36"	VACUUM PACK / SOUS VIDE / AL VACIO	1	BOX / BOÎTE / CAJA	4	773388054780
SP00003	8"Ø	12"	VACUUM PACK / SOUS VIDE / AL VACIO	1	BOX / BOÎTE / CAJA	4	773388054711
SP00006	8"Ø	18"	VACUUM PACK / SOUS VIDE / AL VACIO	1	BOX / BOÎTE / CAJA	4	773388054735
SP00009	8"Ø	24"	VACUUM PACK / SOUS VIDE / AL VACIO	1	BOX / BOÎTE / CAJA	4	773388054766
SP00012	8"Ø	36"	VACUUM PACK / SOUS VIDE / AL VACIO	1	BOX / BOÎTE / CAJA	4	773388054797



SKU # # ITEM # SKU	PRODUCT DESCRIPTION DESCRIPTION DU PRODUIT DESCRIPCIÓN DEL PRODUCTO	CONSUMER PACKAGING EMBALLAGE CONSOMATEUR EMBALAJE DE CONSUMO		MASTER PACKAGING CARTON MAÎTRE EMBALAJE MASTER		UPC CODE CODE CUP CÓDIGO UPC	
		TYPE / TIPO	QTY / QTÉ / CANTI.	TYPE / TIPO	QTY / QTÉ / CANTI.		

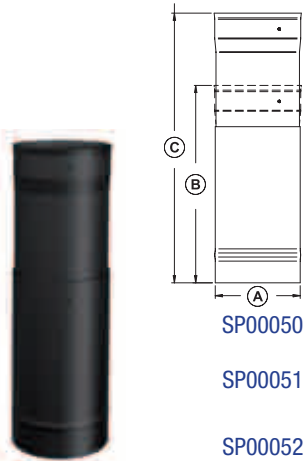

**TELESCOPING STOVE PIPE**  
**TUYAU TÉLESCOPIQUE**  
**TUBO TELESCÓPICO PARA ESTUFA**

Adjusts from 14" to 22". Easily removable for inspection, maintenance and cleaning.  
Réglable de 14" à 22". Facile à enlever pour l'inspection, l'entretien et le nettoyage.  
Ajustable de 14" a 22". Facil a desmontar para la inspección, el mantenimiento y la limpieza.

	AØ	B	C				
SP00050	6"Ø	14"	22"	VACUUM PACK / SOUS VIDE / AL VACIO	1	BOX / BOÎTE / CAJA	773388054841
SP00051	7"Ø	14"	22"	VACUUM PACK / SOUS VIDE / AL VACIO	1	BOX / BOÎTE / CAJA	773388054858
SP00052	8"Ø	14"	22"	VACUUM PACK / SOUS VIDE / AL VACIO	1	BOX / BOÎTE / CAJA	773388054865



**SLIP CONNECTOR**  
**CONNECTEUR COULISSANT**  
**CONECTOR DESLIZANTE**

Designed to connect irregular lengths of stove pipe. The Slip Connector is 18" long and is adjustable from 4" to 18".  
Conçu pour connecter des longueurs irrégulières de tuyau de poêle. Mesure 18" de long et est réglable de 4" à 18".  
Diseñado para conectar longitudes irregulares de tubo. Mide 18" de largo y es ajustable de 4" a 18".

	AØ	B	C				
SP00070	6"Ø	4"	18"	VACUUM PACK / SOUS VIDE / AL VACIO	1	BOX / BOÎTE / CAJA	773388054889
SP00071	7"Ø	4"	18"	VACUUM PACK / SOUS VIDE / AL VACIO	1	BOX / BOÎTE / CAJA	773388054896
SP00072	8"Ø	4"	18"	VACUUM PACK / SOUS VIDE / AL VACIO	1	BOX / BOÎTE / CAJA	773388054902



**45° ELBOW**  
**COUDE 45°**  
**CODO DE 45°**

To use when an offset is needed.  
Utilisé là où une déviation est nécessaire.  
Utilizado cuando una desviación es necesaria.

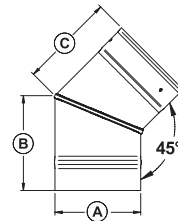

	AØ	B	C				
SP00090	6"Ø	6 5/8"	6 5/8"	VACUUM PACK / SOUS VIDE / AL VACIO	1	BOX / BOÎTE / CAJA	773388054919
SP00091	7"Ø	7 1/16"	7 1/16"	VACUUM PACK / SOUS VIDE / AL VACIO	1	BOX / BOÎTE / CAJA	773388054926
SP00092	8"Ø	7 1/16"	7 1/16"	VACUUM PACK / SOUS VIDE / AL VACIO	1	BOX / BOÎTE / CAJA	773388054933



**90° ELBOW**  
**COUDE 90°**  
**CODO DE 90°**

To use when an offset is needed.  
Utilisé là où une déviation est nécessaire.  
Utilizado cuando una desviación es necesaria.

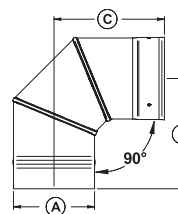

	AØ	B	C				
SP00093	6"Ø	8 1/8"	8 1/8"	VACUUM PACK / SOUS VIDE / AL VACIO	1	BOX / BOÎTE / CAJA	773388054940
SP00094	7"Ø	8 5/8"	8 5/8"	VACUUM PACK / SOUS VIDE / AL VACIO	1	BOX / BOÎTE / CAJA	773388054957
SP00095	8"Ø	9 1/8"	9 1/8"	VACUUM PACK / SOUS VIDE / AL VACIO	1	BOX / BOÎTE / CAJA	773388054964

SKU # # ITEM # SKU	PRODUCT DESCRIPTION DESCRIPTION DU PRODUIT DESCRIPCIÓN DEL PRODUCTO	CONSUMER PACKAGING EMBALLAGE CONSOMATEUR EMBALAJE DE CONSUMO		MASTER PACKAGING CARTON MAÎTRE EMBALAJE MASTER		UPC CODE CODE CUP CÓDIGO UPC	
		TYPE / TIPO	QTY / QTÉ / CANTI.	TYPE / TIPO	QTY / QTÉ / CANTI.		

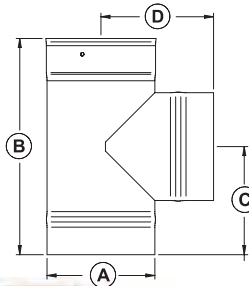

**TEE WITH CAP  
TÉ AVEC BOUCHON  
"T" CON TAPA**

To use when an offset is needed. For easy inspection, maintenance and cleaning.  
Utilisé lorsqu'une déviation est nécessaire. Facilite l'inspection, l'entretien et le nettoyage.  
Se usa cuando una desviación es necesaria. Facilita la inspección, el mantenimiento y la limpieza.



- SP00110
- SP00111
- SP00112

AØ	B	C	D	VACUUM PACK / SOUS VIDE / AL VACIO	1	BOX / BOÎTE / CAJA	1	773388054971
6"Ø	12"	6"	6 1/4"	VACUUM PACK / SOUS VIDE / AL VACIO	1	BOX / BOÎTE / CAJA	1	773388054971
7"Ø	15"	7 1/2"	7 1/4"	VACUUM PACK / SOUS VIDE / AL VACIO	1	BOX / BOÎTE / CAJA	1	773388054988
8"Ø	15"	7 1/2"	7 1/4"	VACUUM PACK / SOUS VIDE / AL VACIO	1	BOX / BOÎTE / CAJA	1	773388054995

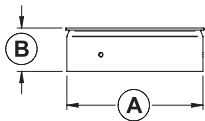

**CAP  
BOUCHON  
TAPA**

AØ B



- SP00130
- SP00131
- SP00132

AØ	B	VACUUM PACK / SOUS VIDE / AL VACIO	1	BOX / BOÎTE / CAJA	1	773388055008
6"Ø	1 15/16"	VACUUM PACK / SOUS VIDE / AL VACIO	1	BOX / BOÎTE / CAJA	1	773388055008
7"Ø	1 15/16"	VACUUM PACK / SOUS VIDE / AL VACIO	1	BOX / BOÎTE / CAJA	1	773388055015
8"Ø	1 15/16"	VACUUM PACK / SOUS VIDE / AL VACIO	1	BOX / BOÎTE / CAJA	1	773388055022

4

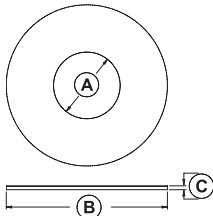

**WALL TRIM COLLAR (ROUND)  
COLLET MURAL DÉCORATIF (ROND)  
COLLAR MURAL DECORATIVO (CIRCULAR)**

Fits around the pipe to give your job a great finishing touch.  
S'insère autour du tuyau pour donner à l'installation une touche de fini admirable.  
Se inserta alrededor del tubo para darle a la instalación un admirable acabado interior.



- SP00150
- SP00151
- SP00152

AØ	B	C	VACUUM PACK / SOUS VIDE / AL VACIO	1	BOX / BOÎTE / CAJA	4	773388055039
6"Ø	14"	1/2"	VACUUM PACK / SOUS VIDE / AL VACIO	1	BOX / BOÎTE / CAJA	4	773388055039
7"Ø	14"	1/2"	VACUUM PACK / SOUS VIDE / AL VACIO	1	BOX / BOÎTE / CAJA	4	773388055046
8"Ø	14"	1/2"	VACUUM PACK / SOUS VIDE / AL VACIO	1	BOX / BOÎTE / CAJA	4	773388055053



**WALL TRIM COLLAR (SQUARE)  
COLLET MURAL DÉCORATIF (CARRÉ)  
COLLAR MURAL DECORATIVO (CUADRADO)**

Fits around the pipe to give your job a great finishing touch.  
S'insère autour du tuyau pour donner à l'installation une touche de fini admirable.  
Se inserta alrededor del tubo para darle a la instalación un admirable acabado interior.

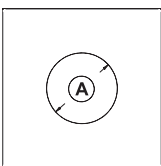

- SP00170
- SP00171
- SP00172

AØ	B	C	VACUUM PACK / SOUS VIDE / AL VACIO	1	BOX / BOÎTE / CAJA	4	773388055060
6"Ø	14"	1/2"	VACUUM PACK / SOUS VIDE / AL VACIO	1	BOX / BOÎTE / CAJA	4	773388055060
7"Ø	14"	1/2"	VACUUM PACK / SOUS VIDE / AL VACIO	1	BOX / BOÎTE / CAJA	4	773388055077
8"Ø	14"	1/2"	VACUUM PACK / SOUS VIDE / AL VACIO	1	BOX / BOÎTE / CAJA	4	773388055084



SKU # # ITEM # SKU	PRODUCT DESCRIPTION DESCRIPTION DU PRODUIT DESCRIPCIÓN DEL PRODUCTO	CONSUMER PACKAGING EMBALLAGE CONSOMATEUR EMBALAJE DE CONSUMO		MASTER PACKAGING CARTON MAÎTRE EMBALAJE MASTER		UPC CODE CODE CUP CÓDIGO UPC
		TYPE / TIPO	QTY / QTÉ / CANTI.	TYPE / TIPO	QTY / QTÉ / CANTI.	

**STOVE PIPE SECTION WITH DAMPER**  
SECTION DE TUYAU AVEC CLÉ  
SECCION DE TUBO CON LLAVE

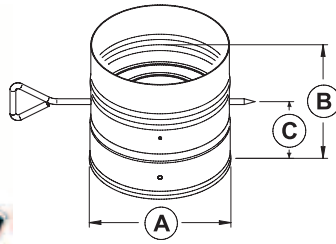

The stove pipe section with damper is fitted between the stove and the first pipe section. It slows down the exhausts and allows for more control in a situation of excessive draft.

La section de tuyau avec clé est installée entre le poêle et la première section du tuyau d'évacuation. Cela diminue le flux de chaleur sortant du poêle pour permettre un plus grand contrôle en situation de tirage excessif.

La sección de tubo con llave se instala entre la estufa y la primera sección del tubo de evacuación. Esto disminuye el flujo de calor que sale de la estufa permitiendo un mayor control en situaciones de tiraje excesivo.

AØ	B	C	VACUUM PACK / SOUS VIDE / AL VACIO	1	BOX / BOÎTE / CAJA	1	773388055107
6"Ø	6"	3"					

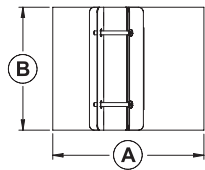

**COUPLING SECTION**  
SECTION D'ACCOUPEMENT  
SECCIÓN DE ACOPLAMIENTO

Joins two sections of pipe. For easy inspection, maintenance and cleaning. Utile pour joindre deux sections de tuyaux. Facilite l'inspection, l'entretien et le nettoyage. Se utiliza para unir dos secciones de tubo. Facilita la inspección, el mantenimiento y la limpieza.

AØ	B	VACUUM PACK / SOUS VIDE / AL VACIO	1	BOX / BOÎTE / CAJA	1	773388055114
6"Ø	6"					
7"Ø	6"					773388055138
8"Ø	6"					773388055145

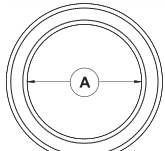

**CAST IRON CONNECTOR FOR TILE**  
CONNECTEUR EN FONTE POUR TUILLE  
CONECTOR EN HIERRO FUNDIDO PARA BALDOSA

Connects the stove pipe to a masonry tile. Utile pour connecter le tuyau aux tuiles. Útil para conectar el tubo a las baldosas.

AØ	B	C	D	VACUUM PACK / SOUS VIDE / AL VACIO	1	BOX / BOÎTE / CAJA	1	773388064048
6"Ø	9"	2"	6"					
7"Ø	10"	2"	7"					773388064055
8"Ø	11"	2"	8"					773388064062

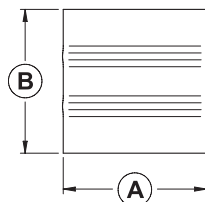
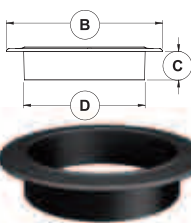

**TILE CONNECTOR ADAPTER**  
ADAPTEUR POUR LE CONNECTEUR POUR TUILLE  
ADAPTADOR PARA EL CONECTOR DE ARCILLA

Connects the stove pipe to the tile connector. Utile pour connecter le tuyau à l'adaptateur pour tuiles. Útil para conectar el tubo al conector de arcilla.

AØ	B	VACUUM PACK / SOUS VIDE / AL VACIO	1	BOX / BOÎTE / CAJA	1	773388055152
6"Ø	6"					
7"Ø	6"					773388055169
8"Ø	6"					773388055176



SKU # # ITEM # SKU	PRODUCT DESCRIPTION DESCRIPTION DU PRODUIT DESCRIPCIÓN DEL PRODUCTO	CONSUMER PACKAGING EMBALLAGE CONSOMMATEUR EMBALAJE DE CONSUMO		MASTER PACKAGING CARTON MAÎTRE EMBALAJE MASTER		UPC CODE CODE CUP CÓDIGO UPC	
		TYPE / TIPO	QTY / QTÉ / CANTI.	TYPE / TIPO	QTY / QTÉ / CANTI.		

**STANDARD SHIELD**  
**ÉCRAN STANDARD**  
**ESCUDO ESTÁNDAR**

Reduces standard clearances from 18" to 6"(USA).  
Utile pour réduire le dégagement standard de 18" à 6"(ÉTATS-UNIS).  
Útil para reducir las distancias estándares de 18" a 6" (ESTADOS UNIDOS).

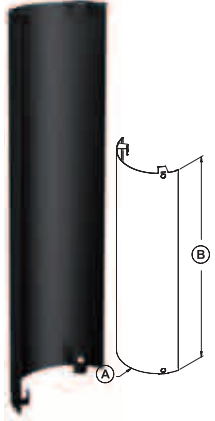

	AØ	B					
SP00256	6"Ø	12"	VACUUM PACK / SOUS VIDE / AL VACIO	1	BOX / BOÎTE / CAJA	4	773388069159
SP00250	6"Ø	24"	VACUUM PACK / SOUS VIDE / AL VACIO	1	BOX / BOÎTE / CAJA	4	773388055183
SP00253	6"Ø	36"	VACUUM PACK / SOUS VIDE / AL VACIO	1	BOX / BOÎTE / CAJA	4	773388055220
SP00259	6"Ø	48"	VACUUM PACK / SOUS VIDE / AL VACIO	1	BOX / BOÎTE / CAJA	4	773388069180
SP00257	7"Ø	12"	VACUUM PACK / SOUS VIDE / AL VACIO	1	BOX / BOÎTE / CAJA	4	773388069166
SP00251	7"Ø	24"	VACUUM PACK / SOUS VIDE / AL VACIO	1	BOX / BOÎTE / CAJA	4	773388055190
SP00254	7"Ø	36"	VACUUM PACK / SOUS VIDE / AL VACIO	1	BOX / BOÎTE / CAJA	4	773388055237
SP00258	8"Ø	12"	VACUUM PACK / SOUS VIDE / AL VACIO	1	BOX / BOÎTE / CAJA	4	773388069173
SP00252	8"Ø	24"	VACUUM PACK / SOUS VIDE / AL VACIO	1	BOX / BOÎTE / CAJA	4	773388055213
SP00255	8"Ø	36"	VACUUM PACK / SOUS VIDE / AL VACIO	1	BOX / BOÎTE / CAJA	4	773388055251

**TELESCOPING STANDARD SHIELD**  
**ÉCRAN STANDARD TÉLESCOPIQUE**  
**ESCUDO TELESCÓPICO ESTÁNDAR**

Adjusts from 14" to 22".  
S'ajuste de 14" à 22".  
Se ajusta desde 14" hasta 22".

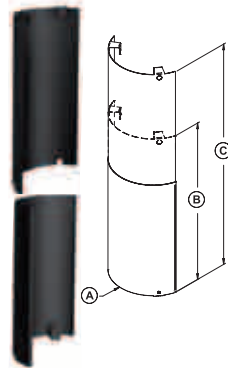

	AØ	B	C				
SP00270	6"Ø	14"	22"	VACUUM PACK / SOUS VIDE / AL VACIO	1	BOX / BOÎTE / CAJA	773388055268
SP00271	7"Ø	14"	22"	VACUUM PACK / SOUS VIDE / AL VACIO	1	BOX / BOÎTE / CAJA	773388055275
SP00272	8"Ø	14"	22"	VACUUM PACK / SOUS VIDE / AL VACIO	1	BOX / BOÎTE / CAJA	773388055282

**STANDARD ELBOW SHIELD**  
**ÉCRAN STANDARD POUR COUDE**  
**ESCUDO ESTÁNDAR PARA CODO**

Allows shielding above the elbows.  
Procure un écran au-dessus des coudes.  
Permite la protección por encima de los codos.

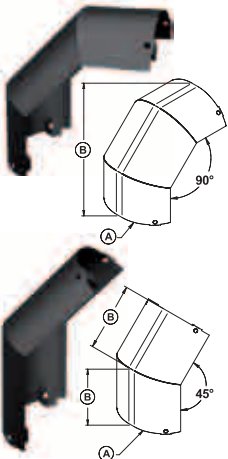

	AØ	B					
SP00290	6"Ø	10"	90°	VACUUM PACK / SOUS VIDE / AL VACIO	1	BOX / BOÎTE / CAJA	773388055312
SP00291	7"Ø	10 1/2"	90°	VACUUM PACK / SOUS VIDE / AL VACIO	1	BOX / BOÎTE / CAJA	773388055329
SP00292	8"Ø	11"	90°	VACUUM PACK / SOUS VIDE / AL VACIO	1	BOX / BOÎTE / CAJA	773388055336
SP00293	6"Ø	6 5/8"	45°	VACUUM PACK / SOUS VIDE / AL VACIO	1	BOX / BOÎTE / CAJA	773388055350
SP00294	7"Ø	6 13/16"	45°	VACUUM PACK / SOUS VIDE / AL VACIO	1	BOX / BOÎTE / CAJA	773388055367
SP00295	8"Ø	7 1/16"	45°	VACUUM PACK / SOUS VIDE / AL VACIO	1	BOX / BOÎTE / CAJA	773388055374

**STOVE CONNECTOR**  
**CONNECTEUR POUR POËLE**  
**CONECTOR PARA ESTUFA**

For easy connection to the stove's flue collar.  
Pour une connexion facile à la buse du poêle.  
Para una fácil conexión a la boquilla de la estufa.

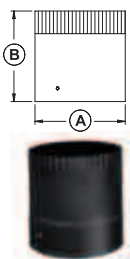

	AØ	B					
SP00350	6"Ø	6"	VACUUM PACK / SOUS VIDE / AL VACIO	1	BOX / BOÎTE / CAJA	1	773388055473
SP00351	7"Ø	6"	VACUUM PACK / SOUS VIDE / AL VACIO	1	BOX / BOÎTE / CAJA	1	773388055480
SP00352	8"Ø	6"	VACUUM PACK / SOUS VIDE / AL VACIO	1	BOX / BOÎTE / CAJA	1	773388055497



SKU # # ITEM # SKU	PRODUCT DESCRIPTION DESCRIPTION DU PRODUIT DESCRIPCIÓN DEL PRODUCTO	CONSUMER PACKAGING EMBALLAGE CONSOMATEUR EMBALAJE DE CONSUMO		MASTER PACKAGING CARTON MAÎTRE EMBALAJE MASTER		UPC CODE CODE CUP CÓDIGO UPC
		TYPE / TIPO	QTY / QTÉ / CANTI.	TYPE / TIPO	QTY / QTÉ / CANTI.	

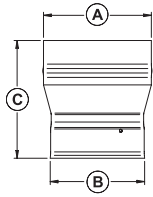

**REDUCER**  
**RÉDUCTEUR**  
**REDUCTOR**

Reduces vent diameter.  
Utilisé pour réduire le diamètre de l'évent.  
Se utiliza para reducir el diámetro del tubo de evacuación.

(M) = MALE / MÂLE / MACHO  
(F) = FEMALE / FEMELLE / HEMBRA

	AØ (M)	BØ (F)	C					
SP00310	6"Ø	5"Ø	7 5/8"	VACUUM PACK / SOUS VIDE / AL VACIO	1	BOX / BOÎTE / CAJA	1	773388055381
SP00311	7"Ø	6"Ø	7 5/8"	VACUUM PACK / SOUS VIDE / AL VACIO	1	BOX / BOÎTE / CAJA	1	773388055398
SP00312	8"Ø	7"Ø	7 5/8"	VACUUM PACK / SOUS VIDE / AL VACIO	1	BOX / BOÎTE / CAJA	1	773388055404
SP00313	8"Ø	6"Ø	8 1/8"	VACUUM PACK / SOUS VIDE / AL VACIO	1	BOX / BOÎTE / CAJA	1	773388055411

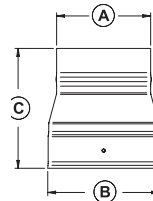

**INCREASER**  
**AGRANDISSEUR**  
**AUMENTADOR**

Increases vent diameter.  
Utilisé pour agrandir le diamètre de l'évent.  
Se utiliza para aumentar el diámetro del tubo de evacuación.

(M) = MALE / MÂLE / MACHO  
(F) = FEMALE / FEMELLE / HEMBRA

	AØ (M)	BØ (F)	C					
SP00330	5"Ø	6"Ø	7 5/8"	VACUUM PACK / SOUS VIDE / AL VACIO	1	BOX / BOÎTE / CAJA	1	773388055428
SP00331	6"Ø	7"Ø	7 5/8"	VACUUM PACK / SOUS VIDE / AL VACIO	1	BOX / BOÎTE / CAJA	1	773388055435
SP00332	7"Ø	8"Ø	7 5/8"	VACUUM PACK / SOUS VIDE / AL VACIO	1	BOX / BOÎTE / CAJA	1	773388055442
SP00333	6"Ø	8"Ø	8 1/8"	VACUUM PACK / SOUS VIDE / AL VACIO	1	BOX / BOÎTE / CAJA	1	773388055466



**BLACK PIPE KIT**  
**ENSEMBLE DE TUYAUX NOIRS**  
**KIT DE TUBOS DE EVACUACIÓN NEGROS**

For installation to the wall or to the ceiling.  
Pour installation au mur ou au plafond.  
Para instalación mural o a través del techo.

SP00360	6"Ø WALL / MUR / MURAL	BOX / BOÎTE / CAJA	1	BOX / BOÎTE / CAJA	1	773388069197
Kit Includes: 2X Black stove pipe 12"L, 1X Black stove pipe 24"L, 1X Telescoping stove pipe 14" - 22"L, 1X Stove connector, 2X 45° elbow, 1X Wall trim collar (square) and 36 self tapping screws.		L'ensemble inclut : 2X tuyau noir 12"L, 1X tuyau noir 24"L, 1X télescopique 14" - 22"L, 1X connecteur pour poêle, 2X coude 45°, 1X collet mural décoratif ( carré ) et 36 vis auto-perçantes.		El kit incluye: 2X tubo de evacuación negro 12"L, 1X tubo de evacuación negro 24"L, 1X tubo telescópico para estufa 14" - 22"L, 1X conector para estufa, 2X codo de 45°, 1X collar mural decorativo ( cuadrado ) y 36 tornillos de autopercutor.		



SP00370	6"Ø CEILING / PLAFOND / TECHO	BOX / BOÎTE / CAJA	1	BOX / BOÎTE / CAJA	1	773388069203
Kit Includes: Telescoping stove pipe 38" - 70"L, Stove connector, Wall trim collar (square) and 36 self tapping screws.		L'ensemble inclut : tuyau télescopique 38" - 70"L, connecteur pour poêle, collet mural décoratif ( carré ) et 36 vis auto-perçantes.		El kit incluye: tubo telescópico para estufa 38" - 70"L, conector para estufa, collar mural decorativo ( cuadrado ) y 36 tornillos de autopercutor.		



**HEAT SHIELD KIT FOR BLACK PIPE KIT**  
**ENSEMBLE D'ÉCRANS POUR ENSEMBLE DE TUYAUX NOIRS**  
**KIT DE ESCUDOS ESTÁNDAR PARA PARA KIT DE TUBOS DE EVACUACIÓN NEGROS**

For installation in combination with the black pipe kit to the ceiling.  
Pour installation en combinaison avec l'ensemble de tuyaux noirs au plafond.  
Para instalación conjunta con el kit de tubos de evacuación negros a través del techo.

SP00390	6"Ø CEILING / PLAFOND / TECHO	BOX / BOÎTE / CAJA	1	BOX / BOÎTE / CAJA	1	773388069227
Kit Includes: telescoping standard shield 38" - 70"L, and 36 self tapping screws.		L'ensemble inclut : écran standard télescopique 38" - 70"L et 36 vis auto-perçantes		El kit incluye : escudo telescópico estándar 38" - 70"L y 36 tornillos de autopercutor.		

1000  
SCREWS  
VIS  
TORNILLOS



AC02500	1000 X #8 1/2" PHILLIPS SQUARE FLAT BLACK / CARRÉE ÉTOILE NOIR MAT / CUADRADO ESTRELLA NEGRO MATE	BOX / BOÎTE / CAJA	1	BOX / BOÎTE / CAJA	6	773389040102
---------	---	--------------------	---	--------------------	---	--------------

36  
SCREWS  
VIS  
TORNILLOS



AC02510	36 X #8 1/2" PHILLIPS SQUARE FLAT BLACK / CARRÉE ÉTOILE NOIR MAT / CUADRADO ESTRELLA NEGRO MATE	BOX / BOÎTE / CAJA	1	BOX / BOÎTE / CAJA	12	773389040119
---------	---	--------------------	---	--------------------	----	--------------



**HEATING ACCESSORIES**  
**ACCESSOIRES DE CHAUFFAGE** ®

PRINTED IN CANADA / IMPRIMÉ AU CANADA / IMPRESO EN CANADA



250, rue de Copenhague  
Saint-Augustin-de-Desmaures  
(Québec) Canada G3A 2H3

☎ 418 878-3040

📠 418 878-3001

@ client@sbi-international.com

PUB158



09-2012